

Data Sheet

E2S Intrinsically Safe Pressure Transducer

FEATURES

- FM, CSA, ATEX, IECEx Intrinsically-Safe approvals, FM Non-Incendive approval
- Ranges vac through 20,000 psi
- IP66/67 Ingress rating
- Wide selection of electrical & process connections available
- Customizable configurations
- External magnetic offset & span adjustment
- Barometric pressure ranges available (standard & custom ranges)
- SIL 3 capable

TYPICAL USES

- Oil field equipment
- Upstream oil & gas production
- Natural gas compression
- Alternative energy projects
- Engine monitoring
- Process & pneumatic sensing
- Hydrogen applications



E2S
Pressure Transducer

PERFORMANCE SPECIFICATIONS

Reference Temperature: 70 °F ±3.6 °F, (21 °C ±2 °C)

Static Accuracy: ±0.25% of span, ±0.50% of span, ±1.0% of span, (0-1.5# Range only available in ±0.5% and 1.0% accuracy) Terminal Point Method includes: hysteresis, linearity, repeatability, offset and span

Stability: ±0.25% year at reference conditions

ENVIRONMENTAL SPECIFICATIONS

Thermal Coefficients: Offset: ±0.005% / °F from -40 °F to 257 °F
(±0.009% / °C from -40 °C to 125 °C)
Span: ±0.005% / °F from -40 °F to 257 °F
(±0.009% / °C from -40 °C to 125 °C)

Temperature Limits: Storage: -58 °F to 257 °F (-50 °C to 125 °C)
Operating: -40 °F to 176 °F (-40 °C to 80 °C)
Media: -40 °F to 176 °F (-40 °C to 80 °C)

Humidity: 0-100% (non-condensing)

FUNCTIONAL SPECIFICATIONS

Response Time (Output) 4 ms

Gauge/Compound Pressure Ranges: VAC to 20,000 psig

Shock: 80 g, 6 ms, Haversine

Vibration: Random: 10 g RMS 20-2000 Hz

Absolute Pressure Ranges: 0 to 500 psia

Proof Pressure: 1.2X - 2X (See Table 1 on page 2)

Burst Pressure: 3X - 8X (See Table 1 on page 2)



KEY BENEFITS

- Highly configurable
- Easy calibration of offset and span
- SIL Certified

ELECTRICAL SPECIFICATIONS

Circuit Protection: Reverse polarity protected

INTRINSICALLY SAFE INSTALLATIONS

Supply Voltage: Output

9-28 Vdc: 0-5 Vdc, 1-5 Vdc, 1-6 Vdc, 0.1-5 Vdc, 0.5-4.5 Vdc

14-28 Vdc: 0-10 Vdc, 1-11 Vdc, 0.1-10 Vdc

9-30 Vdc: 4-20 mA, 20-4 mA (2-wire)

NON-INCENDIVE INSTALLATIONS:

Supply Voltage: Output

9-28 Vdc: 0-5 Vdc, 1-5 Vdc, 1-6 Vdc, 0.1-5 Vdc, 0.5-4.5 Vdc

14-28 Vdc: 0-10 Vdc, 1-11 Vdc, 0.1-10 Vdc

9-30 Vdc: 4-20 mA, 20-4 mA (2-wire)

Adjustability: ±5% of span non-interactive offset & span

Supply Current: <8 mA (Vout)

Current Source/Sink for Voltage Output: 1 mA (source)/ 0.1 mA (sink) MAX.

Withstand/Breakdown: 100 Vdc/Vac, optional 500 Vdc/Vac

Data Sheet

E2S Intrinsically Safe Pressure Transducer

PHYSICAL SPECIFICATIONS

Ingress Rating: IP66 (NEMA 4X) (STD.)
IP67 (IP69K Consult Factory)

WETTED MATERIAL

Diaphragm:	Sensor:	Material:
	A	17-4PH® Stainless steel
	B	316L Stainless steel
	C	316L Stainless steel, liquid isolated
	D	A286

Process Connection: 316L Stainless steel

NON-WETTED MATERIAL

Housing: 316L Stainless steel

EMC TESTING

EMC: Directive 2014/30/EU, and EN61326-1, EN61326-2-3 (Industrial Env.)

Immunity:	Test	Level
	61000-4-2 (ESD)	±4 kV/±8 kV (Contact/Air)
	61000-4-3 (Radiated RF)	10 V/m to 1 GHz, 3 V/m to 2 GHz, 1 V/m to 2.7 GHz
	61000-4-4 (EFT/Burst)	±1 kV (5/50 ns, 5 kHz)
	61000-4-5 (Surge)	±1 kV, Earth to Shield over all I/O lines
	61000-4-6 (Conducted RF)	3 V (0.15 to 80 MHz)
	61000-4-8 (Line Freq. Magnetic)	30 A/m

Emissions: EN 55011 (CISPR 11) Class A, Group 1 & FCC (47 CFR 15)

HAZARDOUS AREA CERTIFICATIONS

Intrinsically Safe Installations

FM

Class 1, Division 1, Groups A, B, C, D T4 -40°C < Ta < 80°C

Class 1, Zone 0, AEx ia IIC T4 Ga -40°C < Ta < 80°C

Class 1, Zone 2, AEx ic IIC T4 Gc -40°C < Ta < 80°C

CSA

Class 1, Division 1, Groups A, B, C, D T4, Ex ia -40°C < Ta < 80°C

Ex ia IIC T4 Ga -40°C < Ta < 80°C

Ex ic IIC T4, Gc -40°C < Ta < 80°C

ATEX

II 1 G Ex ia IIC T4 Ga -40°C < Ta < 80°

II 3 G Ex ic IIC T4 Gc -40°C < Ta < 80°C

IECEX

Ex ia IIC T4 Ga -40°C < Ta < 80°C

Ex ic IIC T4 Gc -40°C < Ta < 80°C

Non-Incendive Installations

FM

Class 1, Division 2, Groups A, B, C, D T4, -40°C < Ta < 80°C

CSA

Class 1, Division 2, Groups A, B, C, D T4, -40°C < Ta < 80°C

TABLE 1: PROOF & BURST PRESSURE MULTIPLIERS

Sensor Range (psi)	A Sensor - 17-4PH® SS		B Sensor - 316L SS		C Sensor - 316L SS ISO		D Sensor - A286	
	Proof	Burst	Proof	Burst	Proof	Burst	Proof	Burst
1.5					3.3X	5X		
5					3X	5X		
10					2X	5X		
15					2X	5X		
30					2X	5X		
45	1.9X	8X	1.4X	8X	3.1X	5X		
50	2X	8X	1.5X	8X	2X	5X		
60	2X	8X	1.5X	8X	2X	5X		
75	1.9X	8X	1.5X	8X	1.9X	5X		
100	2X	8X	1.5X	8X	3.0X	5X		
150	1.9X	8X	1.5X	8X	2X	4X		
200	2X	8X	1.5X	8X	3.0X	3X		
300	1.9X	8X	1.5X	8X	2X	3X		
500	2X	8X	1.2X	5X	2X	3X		
750	1.9X	8X	1.2X	5X				
1000	2X	8X	1.2X	5X				
1500	1.9X	8X	1.2X	5X				
2000	2X	8X	1.2X	5X				
3000	1.9X	5X	1.2X	5X				
5000	1.5X	5X	1.2X	5X			2.4X	5X
7500	1.5X	3X					1.6X	5X
10000	1.2X	3X					1.2X	5X
15000	1.7X	3X					1.7X	5X
20000	1.3X	3X					1.3X	5X
(Compound)								
VAC#					2X	5X		
V&15#					2X	5X		
V&30#					2X	5X		
V&45#	2X	8X	1.5X	8X	3.3X	7.7X		
V&60#	2X	8X	1.5X	8X	2X	5X		
V&100#	2X	8X	1.5X	8X	3X	6X		
V&150#	2X	8X	1.5X	8X	2X	4X		
V&200#	2X	8X	1.5X	8X	3X	4.5X		
V&300#	2X	8X	1.5X	8X	2X	3X		
(psia)								
15					2X	5X		
30					2X	5X		
70					2X	5X		
150					2X	4X		
300					2X	3X		
500					2X	3X		

Data Sheet

E2S Intrinsically Safe Pressure Transducer

ORDERING CODE	Example:	E2S	B	3	C	F02	42	CC	X	10	F	100#	-XNH
Model													
E2S - Intrinsically Safe		E2S											
Sensor Materials - See Table 2 on page 4 for more options													
A - 17-4PH® Stainless steel													
B - 316L Stainless steel			B										
C - 316L Stainless steel (liquid isolated)													
D - A286													
Accuracy													
3 - 0.25% span (not available with 1.5 psi range)				3									
5 - 0.50% span													
7 - 1.00% span													
Calibration Chart													
N - Without calibration chart													
C - Traceable calibration certificate					C								
Pressure Connections - See Table 3 on page 5 for more options													
F02 - (¼ NPT Female)						F02							
Output Type - Note: Consult factory for additional outputs													
05 - 0-5 Vdc (not available with X1L variation)													
10 - 0-10 Vdc (not available with X1L variation)													
11 - 1-11 Vdc													
15 - 1-5 Vdc													
16 - 1-6 Vdc													
24 - 20-4 mA													
42 - 4-20 mA							42						
45 - 0.5-4.5 Vdc non-ratiometric													
00 - Custom													
Electrical Connections - See Table 4 on page 6 for more options													
CC - (½ NPT conduit w/cable)								CC					
Mating Connector													
M - With mating connector													
X - Without mating connector									X				
Cable Length													
Max cable length of 30 ft for outputs 05, 10, 11, 12, 13, 15, 16 and 45. Max cable length of 99 ft for outputs 24 and 42													
00 - No cable													
XX - 01 to 99										10			
Unit of Length													
F - Feet											F		
M - Meter													
N - Inches													
0 - No cable													
Pressure Ranges - Coding example only, see Table 5 on page 7 for more options													
100# - 100 psig												100#	
Options (if choosing an option(s) must include an "X")													
NN - Paper tag													-X
NH - Stainless steel tag													NH
6B - Cleaned for oxygen service													
6W - Cleaned to ASME B40.100 Level IV, NOT marked for oxygen service													
1L - SIL certification for E2 series transducer													

Accessory	Part Number
Offset and Span Adjustment Magnet	266A143-01
Accessories must be ordered separately	

E2S Intrinsically Safe Pressure Transducer

TABLE 2 - SENSOR PRESSURE RANGE

psi	Sensor Material				bar	Sensor Material				inHg	Sensor Material			
	A 17-4PH® SS	B 316L SS	C 316 ISO	D A286		A 17-4PH® SS	B 316L SS	C 316 ISO	D A286		A 17-4PH® SS	B 316L SS	C 316 ISO	D A286
1.5#			•											
5#			•		400MB			•		10IM		•		
10#			•		600MB			•		20IM		•		
15#			•		1BR			•		30IM		•		
30#	•	•	•		1.6BR	•	•	•		50IM	•	•	•	
45#	•	•	•		2BR	•	•	•		100IM	•	•	•	
50#	•	•	•		2.5BR	•	•	•		200IM	•	•	•	
60#	•	•	•		4BR	•	•	•		300IM	•	•	•	
75#	•	•	•		6BR	•	•	•		500IM	•	•	•	
100#	•	•	•		10BR	•	•	•		1000IM	•	•	•	
150#	•	•	•		16BR	•	•	•		VACIM			•	
200#	•	•	•		20BR	•	•	•		V&30IM			•	
250#	•	•	•		25BR	•	•	•		V&60IM	•	•	•	
300#	•	•	•		40BR	•	•	•		V&100IM	•	•	•	
500#	•	•	•		60BR	•	•	•		V&200IM	•	•	•	
750#	•	•			100BR	•	•			30IMA			•	
1000#	•	•			160BR	•	•			50IMA			•	
1500#	•	•			200BR	•	•			100IMA			•	
2000#	•	•			250BR	•		•		200IMA			•	
2500#	•	•			400BR	•		•		300IMA			•	
3000#	•	•			600BR	•		•		500IMA			•	
5000#	•	•		•	1000BR	•		•		1000IMA			•	
7500#	•			•	1400BR			•		20&32IMA			•	
10000#	•			•	VACBR			•		26&32IMA			•	
15000#	•			•	V&1BR			•		700&1100MBA			•	
20000#	•			•	V&1.6BR	•	•	•		900&1100MBA			•	
VAC#			•		V&2BR	•	•	•						
V&15#			•		V&4BR	•	•	•						
V&30#	•	•	•		V&6BR	•	•	•						
V&45#	•	•	•		1BRA			•						
V&60#	•	•	•		1.6BRA			•						
V&100#	•	•	•		2BRA			•						
V&150#	•	•	•		2.5BRA			•						
V&200#	•	•	•		4BRA			•						
V&300#	•	•	•		6BRA			•						
15#A			•		10BRA			•						
30#A			•		16BRA			•						
50#A			•		20BRA			•						
100#A			•		25BRA			•						
120#A			•											
200#A			•											
300#A			•											
500#A			•											

E2S Intrinsically Safe Pressure Transducer

TABLE 3 - PRESSURE CONNECTION DIMENSIONS

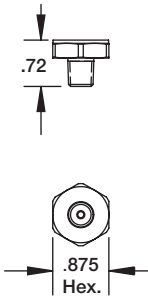
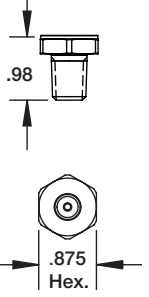
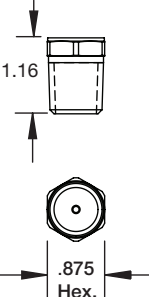
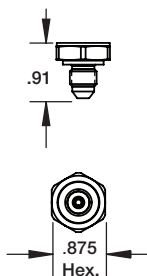
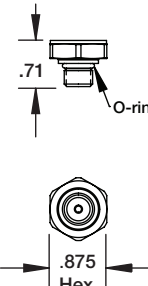
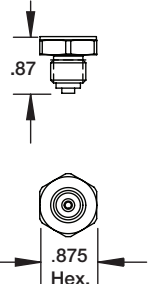
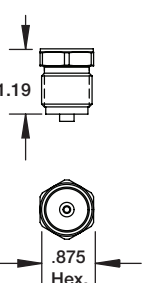
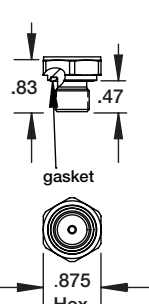
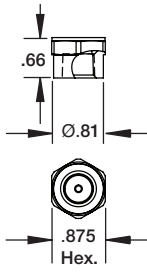
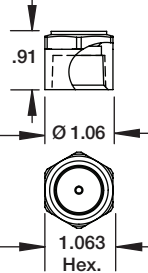
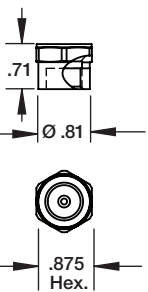
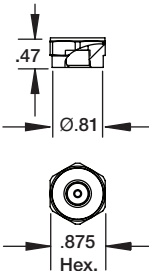
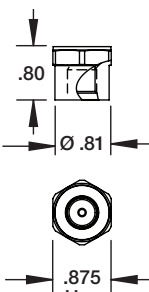
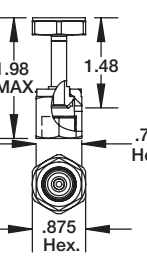
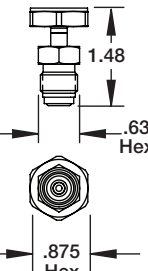
<p>1/8 NPT Male Code: M01 MAWP: 20,000 psi</p>	<p>1/4 NPT Male Code: M02 MAWP: 20,000 psi</p>	<p>1/2 NPT Male Code: M04 MAWP: 10,000 psi</p>	<p>7/16-20 UNJF-3A 37° Flare (SAE AS4395) Code: M76 MAWP: 20,000 psi</p>	<p>7/16-20 UNJF-2A SAE-Male (SAE J1926 O-Ring Boss seal) Code: MEK MAWP: 10,000 psi</p>
				
<p>G1/4 B-Male (EN837-1) Code: MG2 MAWP: 20,000 psi</p>	<p>G1/2 B Male (EN837-1) Code: MG4 MAWP: 20,000 psi</p>	<p>G1/4 A-MALE (stud end DIN 3852-E G1/4) Code: MGA MAWP: 10,000 psi</p>	<p>1/4-18 NPT Female Code: F02 MAWP: 10,000 psi</p>	<p>1/2-14 NPT Female Code: F04 MAWP: 5,000 psi</p>
				
<p>9/16-18 UNF-2B Female Code: F09 MAWP: 25,000 psi</p>	<p>1/8 -27 NPT Female Code: F01 MAWP: 10,000 psi</p>	<p>7/16-20 UNF-2B SAEJ1926 Code: FRW MAWP: 9,100 psi</p>	<p>9/16-18 Female Swivel Nut (compatible with 1/4 VCR® fitting) Code: FV2 MAWP: 5,100 psi</p>	<p>9/16-18 Male Swivel Nut (compatible with 1/4 VCR® fitting) Code: MV2 MAWP: 5,100 psi</p>
				

Data Sheet

E2S Intrinsically Safe Pressure Transducer

TABLE 4 - ELECTRICAL CONNECTION DIMENSIONS

Maximum temperature range listed

Metri-Pack® 3-Pin
Code: GN – IP67 (NEMA 4X)
-40 °F to 185 °F (-40 °C to 80 °C)

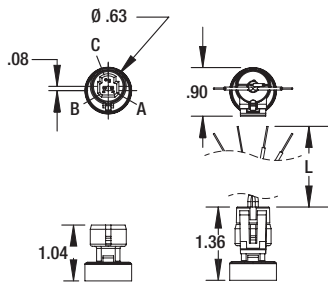

AMP® Superseal® 3-Pin
Code: AP – IP66 (NEMA 4X)
-40 °F to 185 °F (-40 °C to 80 °C)

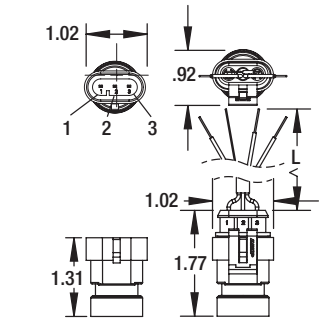

Over-Mold Cable
Code: FC, FV* – IP67 (NEMA 4X)
-40 °F to 185 °F (-40 °C to 80 °C)

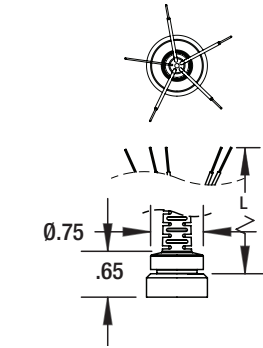

M12 4-Pin
Code: EW – IP66 (NEMA 4X)
-40 °F to 185 °F (-40 °C to 80 °C)

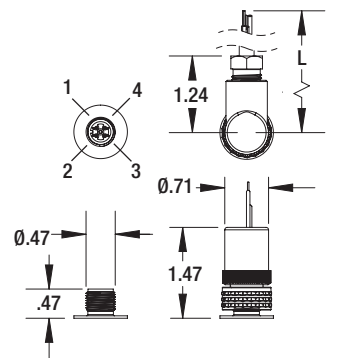

DEUTSCH® DT04 3-Pin
Code: DT – IP66 (NEMA 4X)
-40 °F to 185 °F (-40 °C to 80 °C)

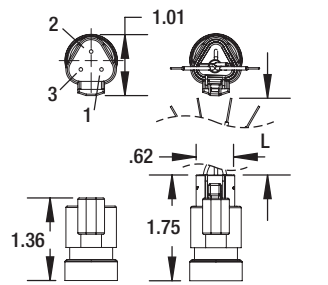

Hirschmann® EN 175301-803 Form A
Code: DA – IP66 (NEMA 4X)
-40 °F to 185 °F (-40 °C to 80 °C)

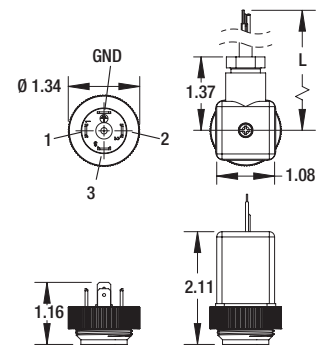

Mini-Hirschmann®
Code: HM – IP66 (NEMA 4X)
-40 °F to 185 °F (-40 °C to 80 °C)

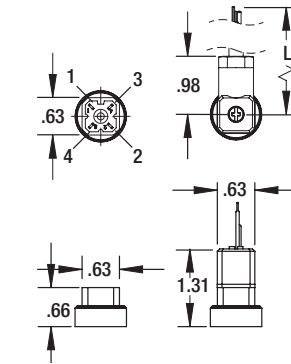

MIL DTL 26482 8 4-Pin
Code: B4 – No IP or NEMA rating
-40 °F to 221 °F (-25 °C to 80 °C)

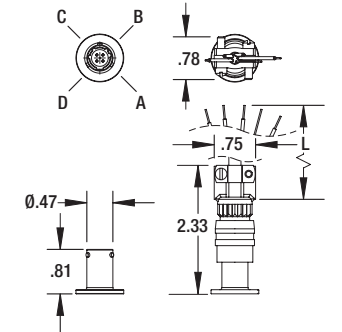

Hirschmann® EN 175301-803 Form C
Code: DC
IP66 (NEMA 4X)
-40 °F to 185 °F (-40 °C to 80 °C)

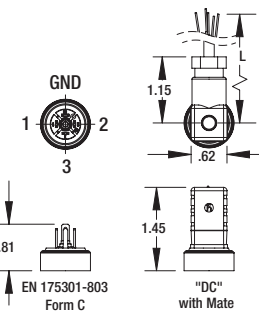

M20 Conduit With Cable
Code: MC, MV*
IP67 (NEMA 4X)
-40 °F to 176 °F (-40 °C to 80 °C)

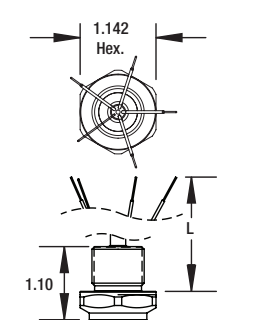

½ NPT Conduit With Cable
Code: CC, CV*
IP67 (NEMA 4X)
-40 °F to 176 °F (-40 °C to 80 °C)

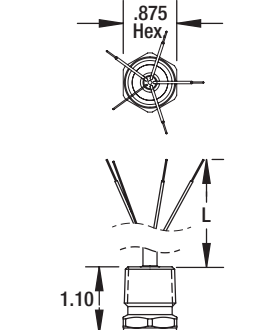

½ NPT Conduit With Flying Leads
Code: CF
IP67 (NEMA 4X)
-40 °F to 176 °F (-40 °C to 80 °C)

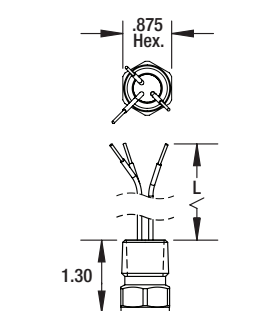

M20 Conduit With Flying Leads
Code: MF
IP67 (NEMA 4X)
-40 °F to 176 °F (-40 °C to 80 °C)

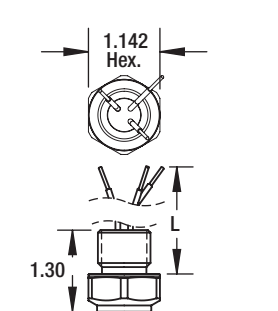

Note: * Indicates Vented Cable

Data Sheet

E2S Intrinsically Safe Pressure Transducer

TABLE 5 - PRESSURE RANGES

	PSI	bar	inHg
Vac.	VAC#	VACBR	VACIM
	V&15#	V&1BR	V&30IM
	—	V&1.6BR	—
	V&30#	V&2BR	V&60IM
	V&45#	—	V&100IM
	V&60#	V&4BR	—
	—	V&6BR	—
	V&100#	—	V&200IM
	V&150#	—	—
	V&200#	—	—
V&300#	—	—	
Compound	1.5#	100MB	3IM
	5#	400MB	10IM
	—	600MB	—
	10#	—	20IM
	15#	1BR	30IM
	—	1.6BR	50IM
	30#	2BR	—
	—	2.5BR	—
	45#	—	—
	50#	—	100IM
	60#	4BR	—
	75#	—	—
	—	6BR	—
	100#	—	200IM
	150#	10BR	300IM
	200#	—	—
	—	16BR	—
	250#	—	500IM
	300#	20BR	—
	—	25BR	—
	500#	—	1000IM
	—	40BR	—
	750#	—	—
	—	60BR	—
	1000#	—	—
1500#	100BR	—	
2000#	160BR	—	
—	200BR	—	
2500#	—	—	
3000#	—	—	
—	250BR	—	
5000#	—	—	
—	400BR	—	
7500#	—	—	
—	600BR	—	
10000#	—	—	
15000#	1000BR	—	
20000#	—	—	
Positive Pressure (psig)	15#A	1BRA	30IMA
	—	1.6BRA	50IMA
	30#A	2BRA	—
	—	2.5BRA	—
	50#A	—	100IMA
	—	4BRA	—
	—	6BRA	—
	100#A	—	200IMA
	—	10BRA	300IMA
	200#A	—	—
Absolute Pressure (psia)	—	16BRA	500IMA
	300#A	20BRA	100IMA
	500#A	25BRA	—

DIMENSIONS

For reference only, consult Ashcroft for specific dimensional drawings

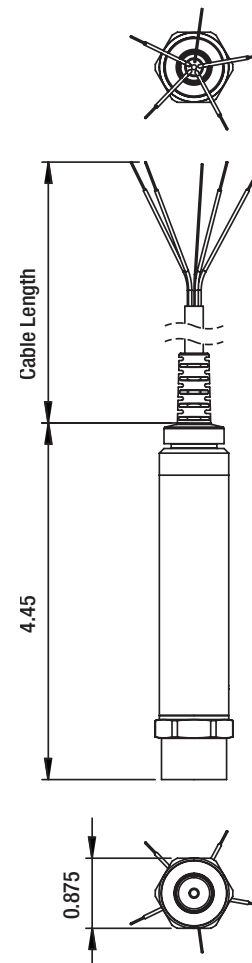
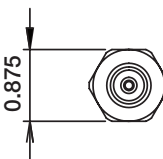
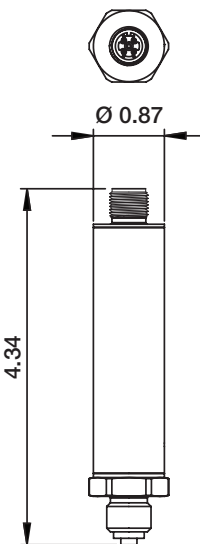
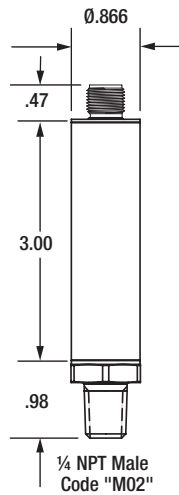

E2S Intrinsically Safe Pressure Transducer

LOOP SUPPLY VOLTAGE CHART

FOR TRANSMITTERS WITH 4-20 mA OUTPUT SIGNAL,
THE MINIMUM VOLTAGE AT THE TERMINAL IS 9 VDC

Loop Supply Voltage vs. Loop Resistance

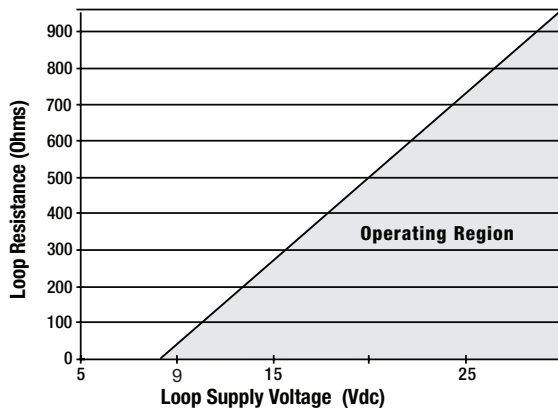

$$V_{\text{MIN}} = 9V + (0.022 \cdot A \times R_{\text{LOOP}}) \text{ (*includes a 10\% safety factor)}$$

$$R_{\text{LOOP}} = R_{\text{SENSE}} + R_{\text{WIRING}}$$

$$R_{\text{LOOP}} = \text{Loop Resistance (Ohms)}$$

$$R_{\text{SENSE}} = \text{Sense Resistance (Ohms)}$$

$$R_{\text{WIRING}} = \text{Wire Resistance (Ohms)}$$

NOTE: See power supply requirement chart
for maximum supply voltage limits

TruAccuracy

What Does It Mean?

Ashcroft's TruAccuracy™ specification is exclusively based on terminal point methodology instead of statistically derived schemes like 'best fit straight line'.

TruAccuracy™ means the Ashcroft E2S has ±0.25% accuracy out of the box. Zero and span setting errors are already included in the ±0.25% accuracy spec.

The E2S is ready to be installed with no additional calibration adjustments required.

A unit from another manufacturer advertised as ±0.25% best fit straight line may actually be a ±1.25% to ±2.25% device. Using best fit straight line method, the accuracy spec does not include zero and span setting errors, which can be as much as ±1.00% each.