

**Installation Instructions for
ASHCROFT® Model 1133 & 1143
Differential Pressure Gauge/Switch**

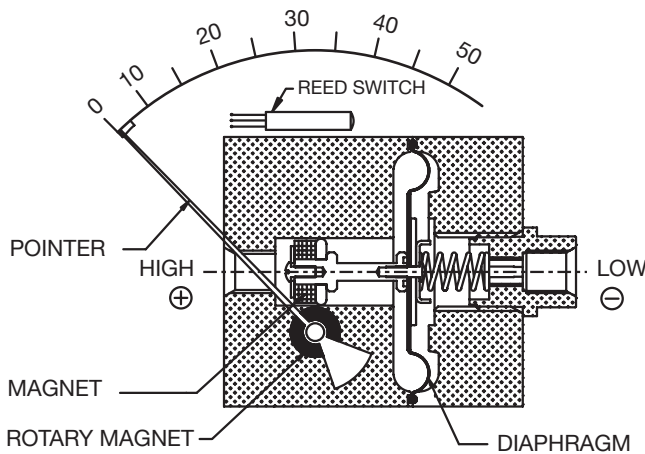

**Model 1133/1143
Large Convoluted Diaphragm**

For proper operation of your gauge, please read all instructions carefully before installing.

CAUTION: Do not exceed maximum operating pressure given on the gauge label. Check fluid compatibility with wetted parts before use.

LIABILITY

The liability of the manufacturer is null and void in case of damage caused by incorrect use, failure to comply with manufacturer's instructions, failure to comply with local accident prevention safety laws and the handling by untrained personnel.

OPERATING PRINCIPLE

High and Low pressures are separated by a sensor assembly consisting of a magnet, diaphragm and a range spring. The difference in pressure causes the sensor assembly to move in proportion to the change against a range spring.

A rotary magnet, located in a separate body compartment and isolated from the acting pressures is rotated by a magnetic coupling following the linear movement of the sensor assembly. A pointer attached to the rotary magnet indicates differential pressure on the dial.

SWITCH: Reed switches (optional) are located adjacent to the pressure chamber and are activated by the magnetic field of the sensor assembly.

Note: The gauges are calibrated to give $\pm 2\%$ full scale accuracy on ascending readings.

INSTALLATION

For better performance the gauge should be mounted horizontally with the dial vertical. Two mounting holes should be used for mounting (when applicable). Select instrument location where it is not subjected to heavy vibration or shock. Depressurize the system and connect the high and low pressure lines of your system to the "High" and "Low" ports of the gauge, respectively.

It is recommended for tapered threads to use thread sealant tape and for parallel threads it is recommended

to use "O" rings with male connectors to avoid excessive tightening and to prevent leakage. The gauge is now ready for operation. Apply "High" and "Low" pressures simultaneously, to avoid damage to the internal parts.

Models 1133 & 1143 consists of a large convoluted diaphragm design for low differential pressure. It can withstand maximum operating pressure up to 500 psi. If pressure exceeds the rated maximum pressure, damage will occur.

PRECAUTIONS

Do not connect "High" and "Low" ports incorrectly. Do not subject the gauge to excessive vibration. The gauge is never to be used in an area where a magnetic field is present as it may show the wrong readings.

As the gauge works on a magnetic coupling principle, use only non-magnetic fittings, parts, etc. in areas closer than 2" on all sides, otherwise calibration will be affected. Panel mounted gauges should be installed in non-ferrous panel material. However, gauges with 2" and 2.5" dials, mounted in steel panels, may require pointer adjustment. This is done by the manufacturer, upon request.

Do not try to open the back housing of the gauge for any reason as calibration will be affected.

SWITCH SETTING

Please follow these instructions when your differential pressure gauges are supplied with a switch. The switches are normally factory set to save time the customer time. However, they are field adjustable.

CAUTION: Supply voltage should not exceed switch rating. For higher supply, adding a relay is recommended.

SWITCH ADJUSTMENT

The following procedure must be done by putting the gauge on a test bench or while in actual service. The switch adjustment screw is located on the plastic cover. Rotate the screw counter clockwise to increase the setpoint and clockwise to decrease the setpoint. One or two trials may be necessary to attain the exact setpoint.

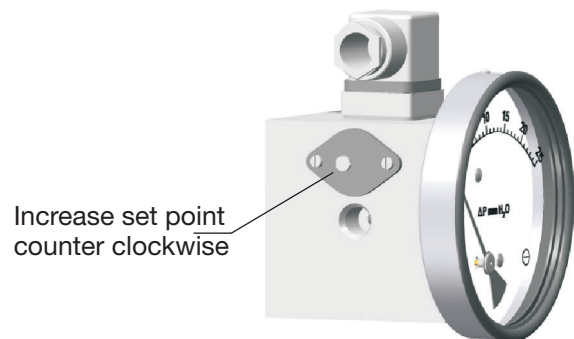

View from high pressure side

**Installation Instructions for
ASHCROFT® Model 1133 & 1143
Differential Pressure Gauge/Switch**



SPST SWITCH

Specifications

Contact Rating : 10 VA ac (rms) or dc (max)
Switching Current : 0.5 Amp ac (rms) or dc (max)
Switch Voltage : 100 Vac/Vdc (max)

SPDT SWITCH

Specifications

Contact Rating : 3 VA ac (rms) or dc (max)
Switching Current : 0.3 Amp ac (rms) or dc (max)
Switch Voltage : 30 Vac/Vdc (max)

ONE SPST SWITCH

**Reed Switches and
DIN Plug Connection**

View of socket for supply connections

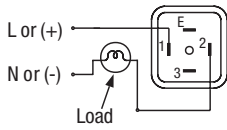

View of plug after removing the socket

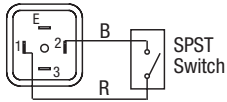

TWO SPST SWITCHES

**Reed Switches and
DIN Plug Connection**

View of socket for supply connections

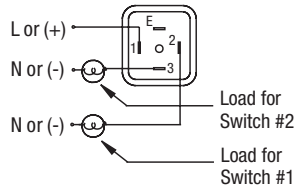

View of plug after removing the socket

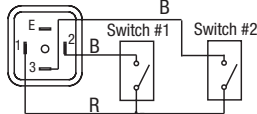

ONE SPDT SWITCH

**Reed Switches and
DIN Plug Connection**

View of socket for supply connections

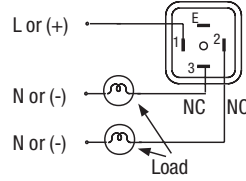

View of plug after removing the socket

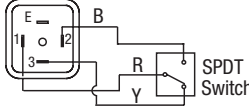

R = Red; B = Black; Y = Yellow; L = Live or + Supply; N = Neutral or - Supply.

*Body to be suitably grounded while using gauge + switch and only switch.