

Data Sheet

E2G Pressure Transducer

FEATURES

- Ranges vac through 20,000 psi
- IP66/67 Ingress rating
- Wide selection of electrical and process connections
- Customizable configurations
- External magnetic offset and span adjustment
- Barometric pressure ranges available (standard and custom ranges)
- SIL 3 capable

TYPICAL USES

- Off-Road equipment
- Construction machinery
- HVAC/Refrigeration
- Compressor control
- Pump monitoring
- Agricultural equipment
- Diagnostic kits
- Engine monitoring
- Process automation and controls
- Hydraulic and pneumatic sensing

PERFORMANCE SPECIFICATIONS

Reference Temperature: 70 °F ±3.6 °F (21 °C ±2 °C)

Static Accuracy: ±0.25% of span, ±0.50% of span, ±1.0% of span, (0-1.5# Range only available in ±0.5% and 1.0% accuracy) Terminal Point Method includes: hysteresis, linearity, repeatability, offset and span

Stability: ±0.25% year at reference conditions

ENVIRONMENTAL SPECIFICATIONS

Thermal Coefficients: Offset: ±0.005% /°F from -40 °F to 257 °F (±0.009% /°C from -40 °C to 125 °C)
Span: ±0.005% /°F from -40 °F to 257 °F (±0.009% /°C from -40 °C to 125 °C)

Temperature Limits: Storage: -58 °F to 257 °F (-50 °C to 125 °C)
Operating: -40 °F to 257 °F (-40 °C to 125 °C)
Media: -40 °F to 257 °F (-40 °C to 125 °C)

Humidity: 0-100% (non-condensing)

FUNCTIONAL SPECIFICATIONS

Response Time (Output) 4 ms

Gauge/Compound Pressure Ranges: VAC to 20,000 psig

Shock: 80 g, 6 ms, Haversine

Vibration: Random: 10 g RMS 20-2000 Hz

Absolute Pressure Ranges: 0 to 500 psia

Proof Pressure: 1.2X - 2X (See Table 1 on page 2)

Burst Pressure: 3X - 8X (See Table 1 on page 2)



E2G Pressure Transducer



KEY BENEFITS

- Highly configurable
- Easy calibration of offset and span
- SIL Certified

ELECTRICAL SPECIFICATIONS

Circuit Protection: Reverse polarity protected

Output Signal: Supply Voltage: (unregulated)

| | Min. | Max. |
|----------------------|--------|--------|
| 0-5 Vdc (3 Wire) | 9 Vdc | 36 Vdc |
| 1-5 Vdc (3 Wire) | 9 Vdc | 36 Vdc |
| 1-6 Vdc (3 Wire) | 9 Vdc | 36 Vdc |
| 0-10 Vdc (3 Wire) | 14 Vdc | 36 Vdc |
| 1-11 Vdc (3 Wire) | 14 Vdc | 36 Vdc |
| 0.1-5 Vdc (3 Wire) | 9 Vdc | 36 Vdc |
| 0.1-10 Vdc (3 Wire) | 14 Vdc | 36 Vdc |
| 0.5-4.5 Vdc (3 Wire) | 9 Vdc | 36 Vdc |
| 4-20 mA (2 Wire) | 9 Vdc | 36 Vdc |
| 20-4 mA (2 Wire) | 9 Vdc | 36 Vdc |

Adjustability: ±5% of span non-interactive offset and span

Supply Current: <8 mA (Vout)

Current Source/Sink for Voltage Output: 1 mA (source)/ 0.1 mA (sink) MAX.

Withstand/Breakdown: 100 Vdc/Vac, optional 500 Vdc/Vac

Data Sheet

E2G Pressure Transducer

PHYSICAL SPECIFICATIONS

Ingress Rating: IP66 (NEMA 4X) (STD.)
IP67 (IP69K Consult Factory)

WETTED MATERIAL

| | | |
|------------|---------|---------------------------------------|
| Diaphragm: | Sensor: | Material: |
| | A | 17-4 PH® Stainless steel* |
| | B | 316L Stainless steel |
| | C | 316L Stainless steel, liquid isolated |
| | D | A286 |

***A* sensor with ranges of 10,000 psi and above include 316 Stainless steel and 17-4 PH® H900 Stainless steel (process connection).

Process Connection: 316L Stainless steel

NON-WETTED MATERIAL

Housing: 316L Stainless steel

EMC TESTING

EMC: Directive 2014/30/EU, and EN61326-1, EN61326-2-3 (Industrial Env.)

| | | |
|-----------|---------------------------------|---|
| Immunity: | 61000-4-2 (ESD) | ±4 kV/±8 kV (Contact/Air) |
| | 61000-4-3 (Radiated RF) | 10 V/m to 1 GHz, 3 V/m to 2 GHz, 1 V/m to 2.7 GHz |
| | 61000-4-4 (EFT/Burst) | ±1 kV (5/50 ns, 5 kHz) |
| | 61000-4-5 (Surge) | ±1 kV, Earth to Shield over all I/O lines |
| | 61000-4-6 (Conducted RF) | 3 V/ (0.15 to 80 MHz) |
| | 61000-4-8 (Line Freq. Magnetic) | 30 A/m |

Emissions: EN 55011 (CISPR 11) Class A, Group 1 & FCC (47 CFR 15)

APPROVALS

CE/UKCA, UL/cUL Recognized component (UL 61010-1, CSA 22.2 61010-1), Electrical Equipment for Measurement, Control, and Laboratory Use.



What Does It Mean?

Ashcroft's TruAccuracy™ specification is exclusively based on terminal point methodology instead of statistically derived schemes like 'best fit straight line'.

TruAccuracy™ means the Ashcroft E2G has ±0.25% of span accuracy out of the box. Zero and span setting errors are already included in the ±0.25% of span accuracy spec.

The E2G is ready to be installed with no additional calibration adjustments required.

A unit from another manufacturer advertised as ±0.25% best fit straight line may actually be a ±1.25% to ±2.25% device. Using best fit straight line method, the accuracy spec does not include zero and span setting errors, which can be as much as ±1.00% each.

TABLE 1: PROOF & BURST PRESSURE MULTIPLIERS

| Sensor Range | A Sensor - 17-4 PH® SS | | B Sensor - 316 LSS | | C Sensor - 316L SS ISO | | D Sensor - A286 | |
|-------------------|------------------------|-------|--------------------|-------|------------------------|-------|-----------------|-------|
| | Proof | Burst | Proof | Burst | Proof | Burst | Proof | Burst |
| (psi) | | | | | | | | |
| 1.5 | | | | | 3.3X | 5X | | |
| 5 | | | | | 3X | 5X | | |
| 10 | | | | | 2X | 5X | | |
| 15 | | | | | 2X | 5X | | |
| 30 | 2X | 8X | 1.5X | 8X | 2X | 5X | | |
| 45 | 1.9X | 8X | 1.4X | 8X | 3.1X | 5X | | |
| 50 | 2.9X | 8X | 2.2X | 8X | 2.8X | 5X | | |
| 60 | 2.4X | 8X | 1.8X | 8X | 2.3X | 5X | | |
| 75 | 1.9X | 8X | 1.5X | 8X | 1.9X | 5X | | |
| 100 | 2X | 8X | 1.5X | 8X | 3X | 5X | | |
| 150 | 2X | 8X | 1.5X | 8X | 2X | 4X | | |
| 200 | 2X | 8X | 1.5X | 8X | 3X | 3X | | |
| 300 | 1.9X | 8X | 1.5X | 8X | 2X | 3X | | |
| 500 | 2X | 8X | 1.2X | 5X | 3X | 4X | | |
| 750 | 1.9X | 8X | 1.2X | 5X | | | | |
| 1000 | 2X | 8X | 1.2X | 5X | | | | |
| 1500 | 1.9X | 8X | 1.2X | 5X | | | | |
| 2000 | 2X | 8X | 1.2X | 5X | | | | |
| 3000 | 1.9X | 5X | 1.2X | 5X | | | | |
| 5000 | 1.5X | 5X | 1.2X | 5X | | | 2.4X | 5X |
| 7500 | 1.5X | 3X | | | | | 1.6X | 5X |
| 10,000 | 1.2X | 3X | | | | | 1.2X | 5X |
| 15,000 | 1.7X | 3X | | | | | 1.7X | 5X |
| 20,000 | 1.3X | 3X | | | | | 1.3X | 5X |
| (Compound) | | | | | | | | |
| VAC# | | | | | 2X | 5X | | |
| V&15# | | | | | 2X | 5X | | |
| V&30# | | | | | 2X | 5X | | |
| V&45# | 2X | 8X | 1.5X | 8X | | | | |
| V&60# | 2X | 8X | 1.5X | 8X | 2X | 5X | | |
| V&100# | 2X | 8X | 1.5X | 8X | | | | |
| V&150# | 2X | 8X | 1.5X | 8X | 2X | 4X | | |
| V&200# | 2X | 8X | 1.5X | 8X | | | | |
| V&300# | 2X | 8X | 1.5X | 8X | 2X | 3X | | |
| (psia) | | | | | | | | |
| 15 | | | | | 2X | 5X | | |
| 30 | | | | | 2X | 5X | | |
| 50 | | | | | 2X | 5X | | |
| 150 | | | | | 2X | 4X | | |
| 300 | | | | | 2X | 3X | | |
| 500 | | | | | 2X | 3X | | |

Data Sheet

E2G Pressure Transducer

| ORDERING CODE | Example: | E2G | B | 3 | C | F02 | 42 | CC | X | 10 | F | 100# | -XNH |
|--|----------|-----|---|---|-----|-----|----|----|---|----|---|------|------|
| Model | | | | | | | | | | | | | |
| E2G - General Purpose | | E2G | | | | | | | | | | | |
| Sensor Materials - See Table 2 on page 4 for more options | | | | | | | | | | | | | |
| A - 17-4 PH® Stainless steel | | | | | | | | | | | | | |
| B - 316L Stainless steel | | | B | | | | | | | | | | |
| C - 316L Stainless steel (liquid isolated) | | | | | | | | | | | | | |
| D - A286 | | | | | | | | | | | | | |
| Accuracy | | | | | | | | | | | | | |
| 3 - 0.25% span (not available with 1.5 psi range) | | | | 3 | | | | | | | | | |
| 5 - 0.50% span | | | | | | | | | | | | | |
| 7 - 1.00% span | | | | | | | | | | | | | |
| Calibration Chart | | | | | | | | | | | | | |
| N - Without calibration chart | | | | | | | | | | | | | |
| C - With calibration chart | | | | | C | | | | | | | | |
| Pressure Connections - See Table 3 on page 5 for more options | | | | | | | | | | | | | |
| F02 - (¼ NPT Female) | | | | | F02 | | | | | | | | |
| Output Type | | | | | | | | | | | | | |
| 05 - 0-5 Vdc | | | | | | | | | | | | | |
| 10 - 0-10 Vdc | | | | | | | | | | | | | |
| 11 - 1-11 Vdc | | | | | | | | | | | | | |
| 12 - 1-10 Vdc | | | | | | | | | | | | | |
| 13 - 0.1-5 Vdc | | | | | | | | | | | | | |
| 15 - 1-5 Vdc | | | | | | | | | | | | | |
| 16 - 1-6 Vdc | | | | | | | | | | | | | |
| 42 - 4-20 mA | | | | | | 42 | | | | | | | |
| 45 - 0.5-4.5 Vdc non-ratiometric | | | | | | | | | | | | | |
| 00 - Custom | | | | | | | | | | | | | |
| Electrical Connections - See Table 4 on page 6 for more options | | | | | | | | | | | | | |
| CC - (½ NPT conduit w/cable) | | | | | | | | CC | | | | | |
| Mating Connector | | | | | | | | | | | | | |
| M - With mating connector | | | | | | | | | | | | | |
| X - Without mating connector | | | | | | | | | X | | | | |
| Cable Length | | | | | | | | | | | | | |
| Max cable length of 30ft for outputs 05, 10, 11, 12, 13, 15, 16 and 45; Max cable length of 99ft for outputs 24 and 42 | | | | | | | | | | | | | |
| 00 - No cable | | | | | | | | | | | | | |
| XX - 01 to 99 | | | | | | | | | | 10 | | | |
| Unit of Length | | | | | | | | | | | | | |
| F - Feet | | | | | | | | | | | F | | |
| M - Meter | | | | | | | | | | | | | |
| N - Inches | | | | | | | | | | | | | |
| 0 - No cable | | | | | | | | | | | | | |
| Pressure Ranges - Coding example only, see Table 5 on page 7 for more options | | | | | | | | | | | | | |
| 100# - 100 psig | | | | | | | | | | | | 100# | |
| Options (if choosing an option(s) must include an "X") | | | | | | | | | | | | | -X__ |
| NN - Paper tag | | | | | | | | | | | | | |
| NH - Stainless steel tag | | | | | | | | | | | | | NH |
| 6B - Cleaned for oxygen service | | | | | | | | | | | | | |
| 6W - Cleaned per ASME B40.100 Level IV, NOT marked for oxygen service | | | | | | | | | | | | | |
| 1L - SIL Certification for E2 series transducers | | | | | | | | | | | | | |

| Accessory | Part Number |
|--|-------------|
| Offset and Span Adjustment Magnet | 266A143-01 |
| Accessories must be ordered separately | |

E2G Pressure Transducer

TABLE 2 - SENSOR PRESSURE RANGE

| psi | Sensor Material | | | | bar | Sensor Material | | | | inHg | Sensor Material | | | |
|--------|-----------------|--------------|--------------|-----------|---------|-----------------|--------------|--------------|-----------|-------------|-----------------|--------------|--------------|-----------|
| | A 17-PH® SS | B 316L SS | C 316 ISO | D A286 | | A 17-PH® SS | B 316L SS | C 316 ISO | D A286 | | A 17-PH® SS | B 316L SS | C 316 ISO | D A286 |
| 1.5# | | | • | | | | | | | | | | | |
| 5# | | | • | | 400MB | | | • | | 10IM | | • | | |
| 10# | | | • | | 600MB | | | • | | 20IM | | • | | |
| 15# | | | • | | 1BR | | | • | | 30IM | | • | | |
| 30# | • | • | • | | 1.6BR | | | • | | 50IM | | • | | |
| 45# | • | • | • | | 2BR | | | • | | 100IM | • | • | • | |
| 50# | • | • | • | | 2.5BR | • | • | • | | 200IM | • | • | • | |
| 60# | • | • | • | | 4BR | • | • | • | | 300IM | • | • | • | |
| 75# | • | • | • | | 6BR | • | • | • | | 500IM | • | • | • | |
| 100# | • | • | • | | 10BR | • | • | • | | 1000IM | • | • | | |
| 150# | • | • | • | | 16BR | • | • | • | | VACIM | | | • | |
| 200# | • | • | • | | 20BR | • | • | • | | V&30IM | | | • | |
| 250# | • | • | • | | 25BR | • | • | • | | V&60IM | | | • | |
| 300# | • | • | • | | 40BR | • | • | • | | V&100IM | • | • | • | |
| 500# | • | • | • | | 60BR | • | • | • | | V&200IM | • | • | • | |
| 750# | • | • | • | | 100BR | • | • | • | | 30IMA | | | • | |
| 1000# | • | • | • | | 160BR | • | • | • | | 50IMA | | | • | |
| 1500# | • | • | • | | 200BR | • | • | • | | 100IMA | | | • | |
| 2000# | • | • | • | | 250BR | • | • | • | | 200IMA | | | • | |
| 2500# | • | • | • | | 400BR | • | • | • | | 300IMA | | | • | |
| 3000# | • | • | • | | 600BR | • | • | • | | 500IMA | | | • | |
| 5000# | • | • | • | • | 1000BR | • | • | • | | 1000IMA | | | • | |
| 7500# | • | • | • | • | VACBR | | | • | | 20&32IMA | | | • | |
| 10000# | • | • | • | • | V&1BR | | | • | | 26&32IMA | | | • | |
| 15000# | • | • | • | • | V&1.6BR | | | • | | 700&1100MBA | | | • | |
| 20000# | • | • | • | • | V&2BR | | | • | | 900&1100MBA | | | • | |
| VAC# | | | • | | V&4BR | • | • | • | | | | | | |
| V&15# | • | • | • | | V&6BR | • | • | • | | | | | | |
| V&30# | • | • | • | | 1BRA | | | • | | | | | | |
| V&45# | • | • | • | | 1.6BRA | | | • | | | | | | |
| V&60# | • | • | • | | 2BRA | | | • | | | | | | |
| V&100# | • | • | • | | 2.5BRA | | | • | | | | | | |
| V&150# | • | • | • | | 4BRA | | | • | | | | | | |
| V&200# | • | • | • | | 6BRA | | | • | | | | | | |
| V&300# | • | • | • | | 10BRA | | | • | | | | | | |
| 15#A | | | • | | 16BRA | | | • | | | | | | |
| 30#A | | | • | | 20BRA | | | • | | | | | | |
| 50#A | | | • | | | | | | | | | | | |
| 100#A | | | • | | | | | | | | | | | |
| 120#A | | | • | | | | | | | | | | | |
| 300#A | | | • | | | | | | | | | | | |

Data Sheet

E2G Pressure Transducer

TABLE 3 - PRESSURE CONNECTION DIMENSIONS

1/8 NPT Male

Code: M01

MAWP: 20,000 psi

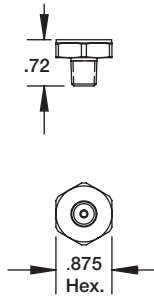

1/4 NPT Male

Code: M02

MAWP: 20,000 psi

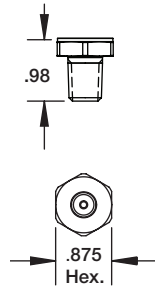

1/2 NPT Male

Code: M04

MAWP: 10,000 psi

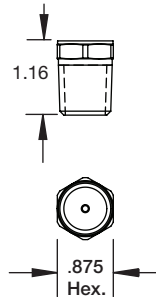

7/16-20 UNJF-3A 37° Flare (SAE AS4395)

Code: M76

MAWP: 20,000 psi

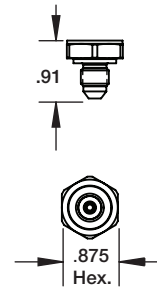

7/16-20 UNJF-2A SAE-Male (SAE J1926 O-Ring Boss seal)

Code: MEK

MAWP: 10,000 psi

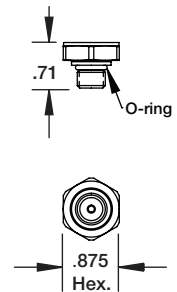

G1/4 B-Male (EN837-1)

Code: MG2

MAWP: 20,000 psi

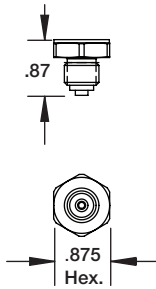

G1/2 B Male (EN837-1)

Code: MG4

MAWP: 20,000 psi

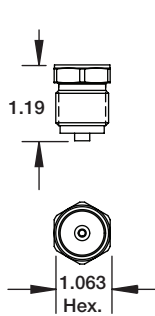

G1/4 A-MALE (stud end DIN 3852-E G1/4)

Code: MGA

MAWP: 10,000 psi

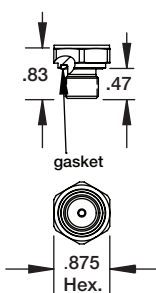

1/4-18 NPT Female

Code: F02

MAWP: 10,000 psi

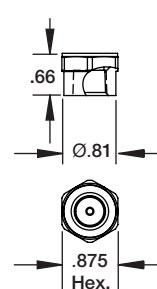

1/2-14 NPT Female

Code: F04

MAWP: 5,000 psi

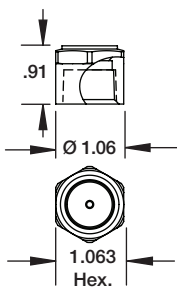

9/16-18 UNF-2B Female

Code: F09

MAWP: 25,000 psi

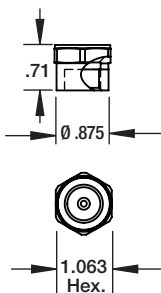

1/8 -27 NPT Female

Code: F01

MAWP: 10,000 psi

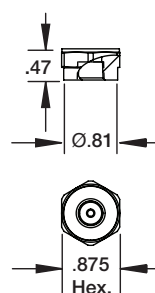

7/16-20 UNF-2B SAE J1926

Code: FRW

MAWP: 9,100 psi

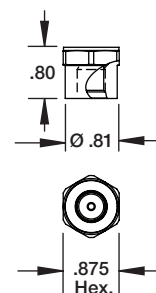

1/4 Compatible with VCR® gland with 9/16-18 Female Swivel

Code: FV2

MAWP: 5,100 psi

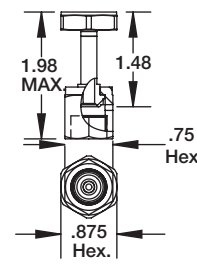

1/4 Compatible with VCR® gland with 9/16-18 Male Swivel Nut

Code: MV2

MAWP: 5,100 psi

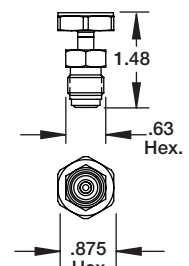

Data Sheet

E2G Pressure Transducer

TABLE 4 - ELECTRICAL CONNECTION DIMENSIONS

Maximum temperature range listed

Metri-Pack® 3-Pin
Code: GN – IP67 (NEMA 4X)
-40 °F to 185 °F (-40 °C to 85 °C)

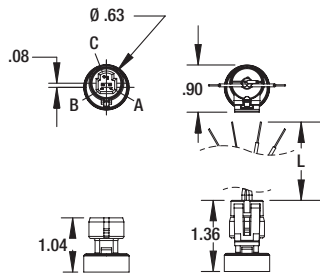

AMP® Superseal® 3-Pin
Code: AP – IP66 (NEMA 4X)
-40 °F to 185 °F (-40 °C to 85 °C)

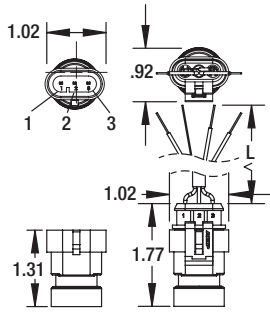

Over-Mold Cable
Code: FC, FV* – IP67 (NEMA 4X)
-40 °F to 185 °F (-40 °C to 85 °C)

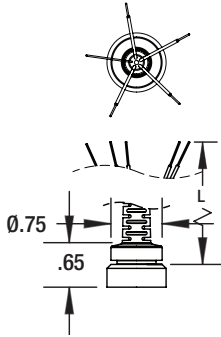

M12 4-Pin
Code: EW, RW** – IP66 (NEMA 4X)
-40 °F to 185 °F (-40 °C to 85 °C)

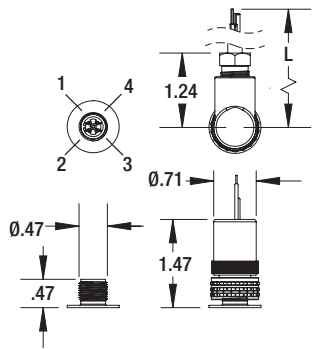

DEUTSCH® DT04 3-Pin
Code: DT – IP66 (NEMA 4X)
-40 °F to 185 °F (-40 °C to 85 °C)

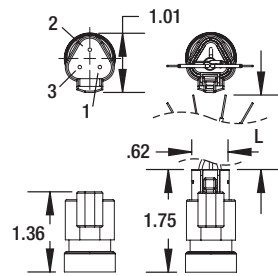

Hirschmann® EN 175301-803 Form A
Code: DA – IP65 (NEMA 4X)
-40 °F to 185 °F (-40 °C to 85 °C)

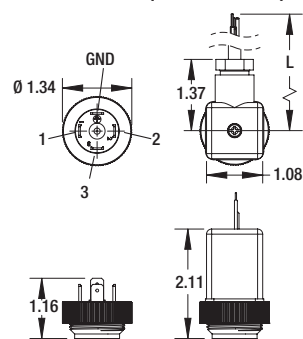

Mini-Hirschmann®
Code: HM – IP65 (NEMA 4X)
-40 °F to 185 °F (-40 °C to 85 °C)

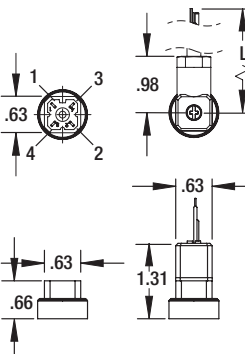

MIL DTL 26482 8 4-Pin
Code: B4 – No IP or NEMA rating
-40 °F to 221 °F (-25 °C to 105 °C)

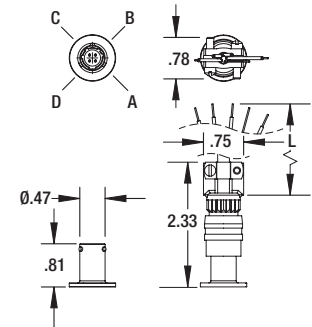

Hirschmann® EN 175301-803 Form C
Code: DC
IP65 (NEMA 4X)
-40 °F to 185 °F (-40 °C to 85 °C)

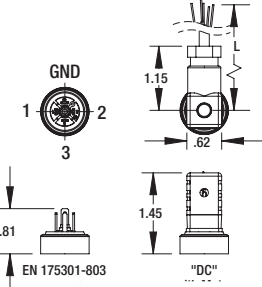

M20 Conduit With Cable
Code: MC, MV*
IP67 (NEMA 4X)
-40 °F to 257 °F (-40 °C to 125 °C)

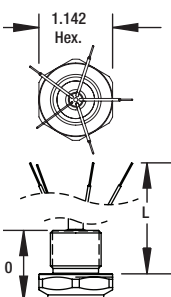

1/2 NPT Conduit With Cable
Code: CC, CV*
IP67 (NEMA 4X)
-40 °F to 257 °F (-40 °C to 125 °C)

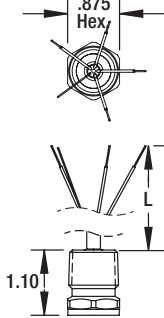

1/2 NPT Conduit With Flying Leads
Code: CF
IP67 (NEMA 4X)
-40 °F to 257 °F (-40 °C to 125 °C)

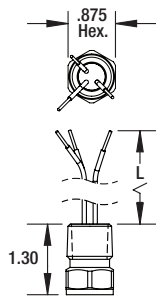

M20 Conduit With Flying Leads
Code: MF
IP67 (NEMA 4X)
-40 °F to 257 °F (-40 °C to 125 °C)

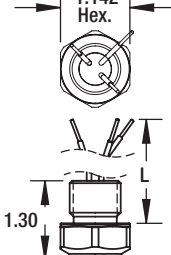

Notes:
* Indicates Vented Cable
** See EW and RW pin-outs on page 8

Data Sheet

E2G Pressure Transducer

TABLE 5 - PRESSURE RANGES

| Vac. | PSI | bar | inHg |
|---------|---------|---------|-------|
| VAC# | VACBR | VACIM | VACIM |
| V&15# | V&1BR | V&30IM | |
| — | V&1.6BR | — | |
| V&30# | V&2BR | V&60IM | |
| V&45# | — | V&100IM | |
| V&60# | V&4BR | — | |
| — | V&6BR | — | |
| V&100# | — | V&200IM | |
| V&150# | — | — | |
| V&200# | — | — | |
| V&300# | — | — | |
| 1.5# | 105MB | 3IM | |
| 5# | 400MB | 10IM | |
| — | 600MB | — | |
| 10# | — | 20IM | |
| 15# | 1BR | 30IM | |
| — | 1.6BR | 50IM | |
| 30# | 2BR | — | |
| — | 2.5BR | — | |
| 45# | — | — | |
| 50# | — | 100IM | |
| 60# | 4BR | — | |
| 75# | — | — | |
| — | 6BR | — | |
| 100# | — | 200IM | |
| 150# | 10BR | 300IM | |
| 200# | — | — | |
| — | 16BR | — | |
| 250# | — | 500IM | |
| 300# | 20BR | — | |
| — | 25BR | — | |
| 500# | — | 1000IM | |
| — | 40BR | — | |
| 750# | — | — | |
| — | 60BR | — | |
| 1000# | — | — | |
| 1500# | 100BR | — | |
| 2000# | 160BR | — | |
| — | 200BR | — | |
| 2500# | — | — | |
| 3000# | — | — | |
| — | 250BR | — | |
| 5000# | — | — | |
| — | 400BR | — | |
| 7500# | — | — | |
| — | 600BR | — | |
| 10,000# | — | — | |
| 15,000# | 1000BR | — | |
| 20,000# | — | — | |
| 15#A | 1BRA | 30IMA | |
| — | 1.6BRA | 50IMA | |
| 30#A | 2BRA | — | |
| — | 2.5BRA | — | |
| 50#A | — | 100IMA | |
| — | 4BRA | — | |
| — | 6BRA | — | |
| 100#A | — | 200IMA | |
| — | 10BRA | 300IMA | |
| 200#A | — | — | |
| — | 16BRA | 500IMA | |
| — | 20BRA | — | |
| 500#A | — | — | |

DIMENSIONS

For reference only, consult Ashcroft for specific dimensional drawings

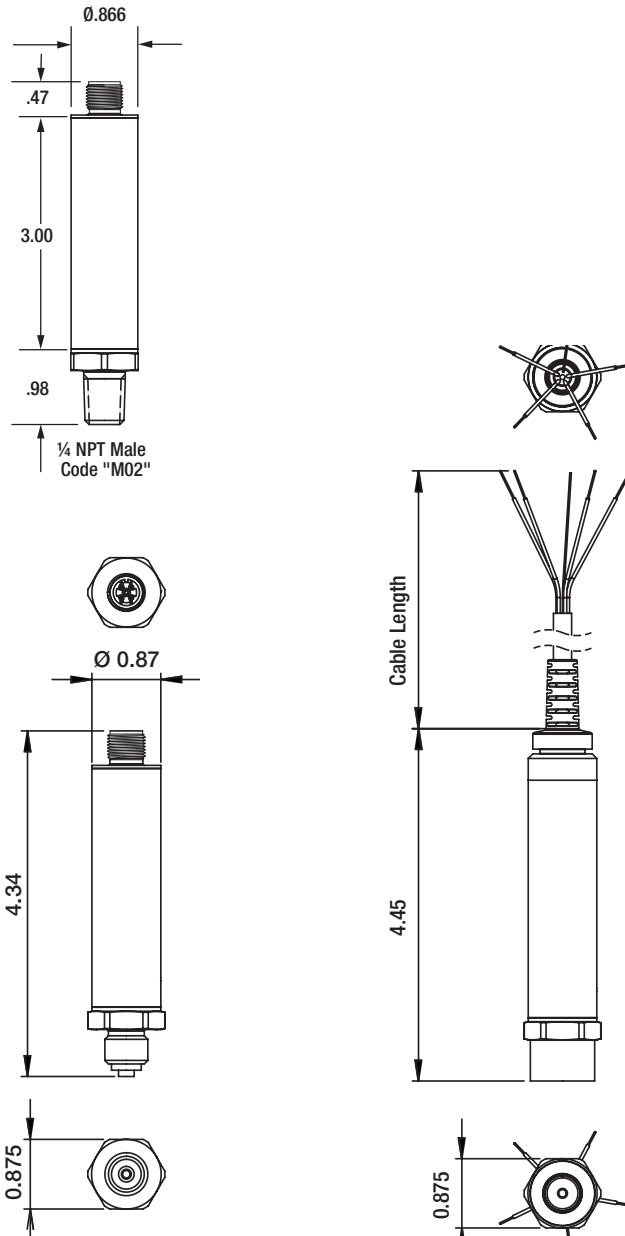

E2G Pressure Transducer

EW AND RW PIN-OUT DRAWINGS

EW CURRENT OUTPUT

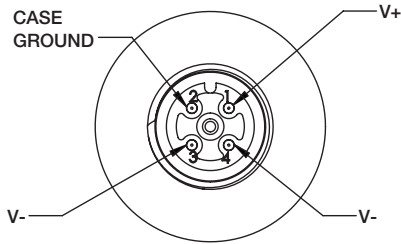

EW VOLTAGE OUTPUT

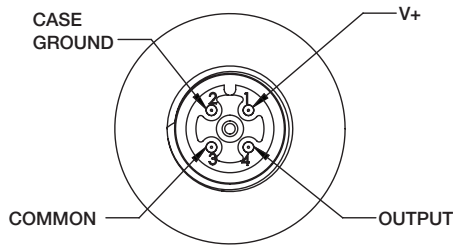

RW CURRENT OUTPUT

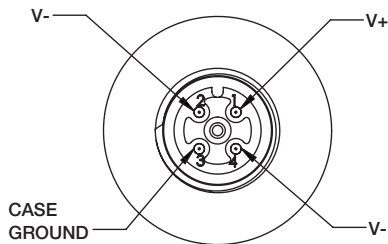

RW VOLTAGE OUTPUT

